

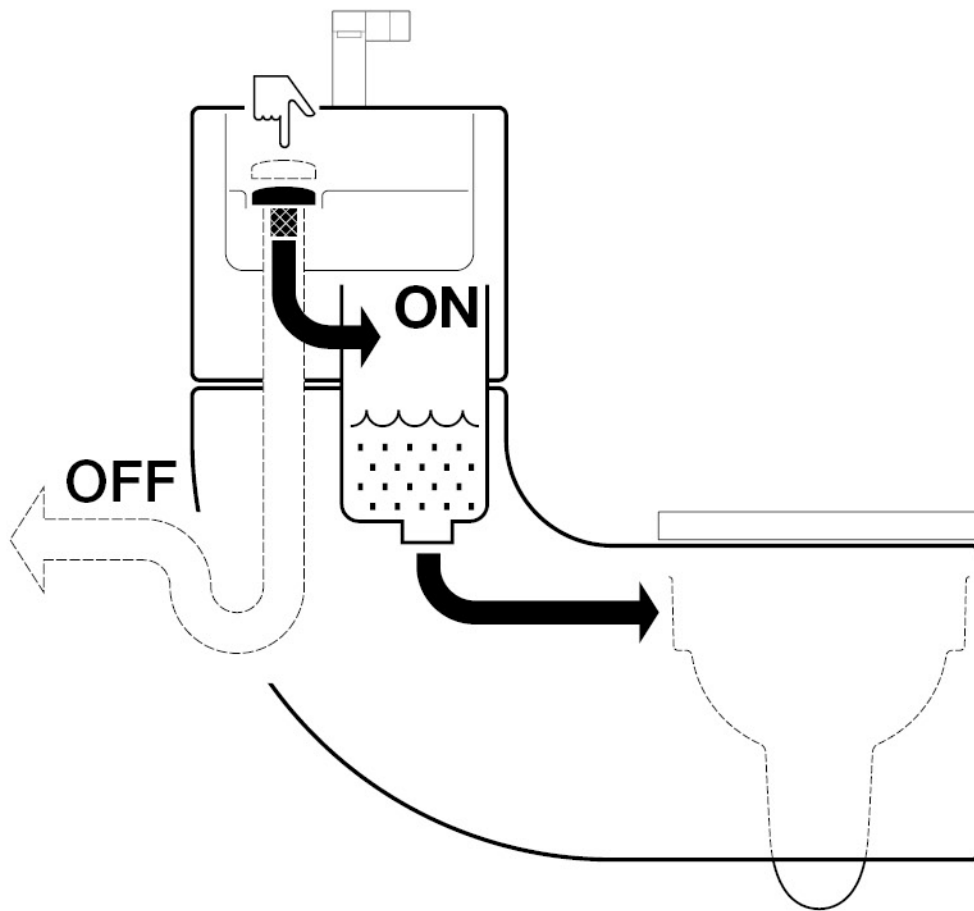

Roca

W+W

8-93020001



RECYCLING OFF



NO



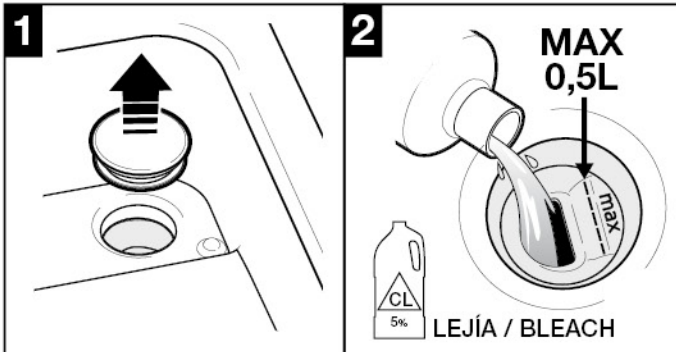
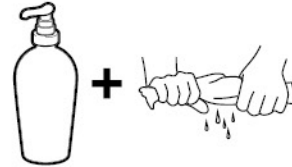
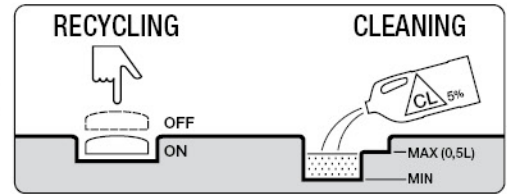
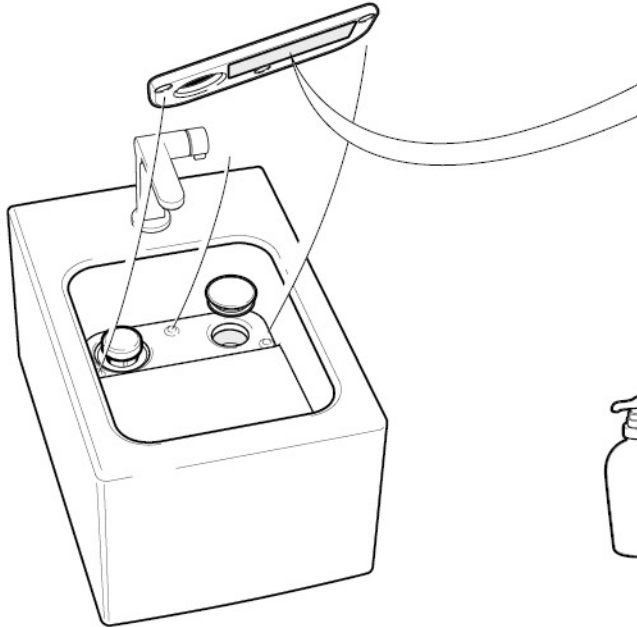

MANTENIMIENTO DE LAS CONDICIONES HIGIÉNICAS EN EL AGUA ACUMULADA

MAINTENANCE OF HYGIENIC CONDITIONS OF STORED WATER

El equipo dispone de un depósito interior dispensador de lejía, el cual aporta la dosis adecuada según el uso. Se recomienda revisar periódicamente el nivel de lejía (aprox. 1 vez al mes).

The equipment includes an inside tank for bleach, which is released to stored water depending on use.

It is recommended to check periodically the bleach level (i.e. once a month).

MANTENIMIENTO DEL FILTRO

FILTER MAINTENANCE

Es aconsejable una limpieza regular del filtro, cada quince días o siempre que el uso lo requiera. Éste se puede limpiar con agua en el mismo grifo del lavabo, ya que al desmontar el filtro, queda anulada la función de reciclado.

It is recommended to perform a regular cleaning of the filter, every two weeks or whenever it is necessary. It can be cleaned under running water in the washbasin. The recycling mode is unavailable when the filter system is disassembled.

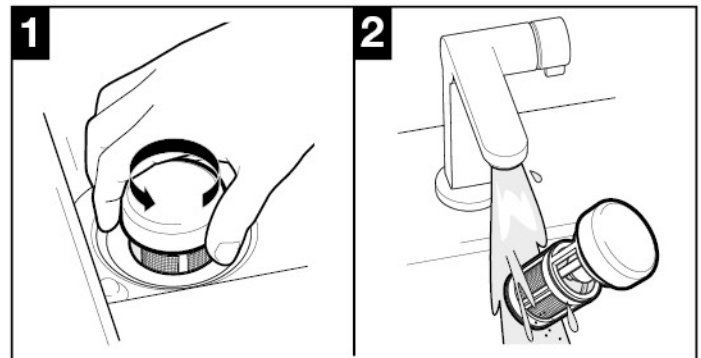

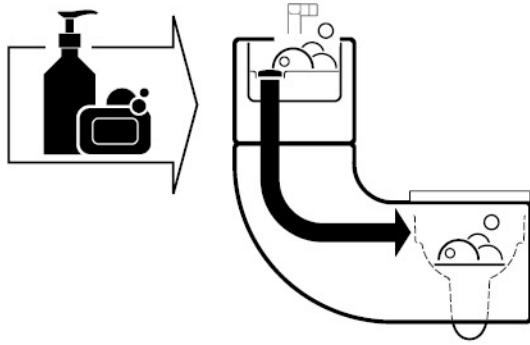

LEJÍA / BLEACH



PERIODO PROLONGADO SIN UTILIZACIÓN

LONG PERIOD WITHOUT USE

En caso de un período prolongado sin utilización se deben realizar 3 descargas completas sin hacer uso del lavabo, garantizando así las renovación del agua de los depósitos (eliminación de agua gris).

Alternativa: cerrar la llave de paso del agua y vaciar completamente los depósitos con 2 descargas completas.

When not using for a long period, it is necessary to make 3 full flushes without using the washbasin, to guarantee the water renewal in the tanks (grey water removing).

Alternate option: close the water intake valve and empty entirely the tanks, by making 2 full flushes.

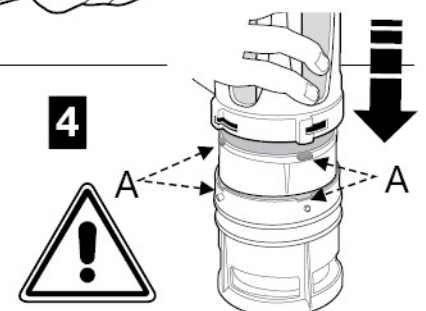
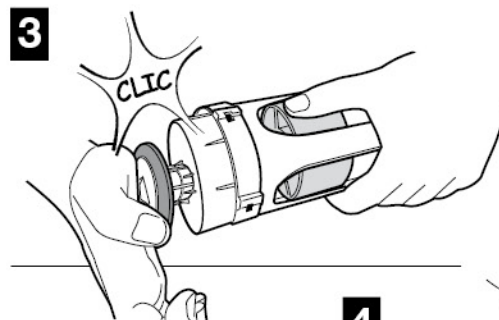
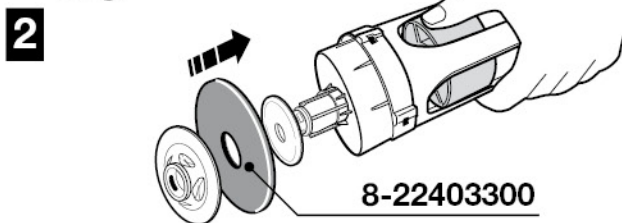
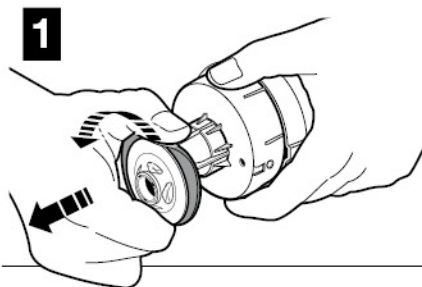
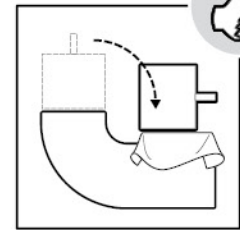
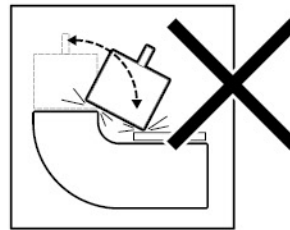
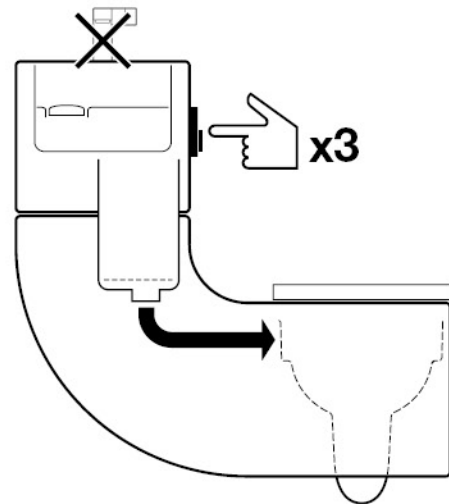



Roca Sanitario, S.A.

Avda. Diagonal, 513
08029 Barcelona
SPAIN
www.roca.com

**902
304
848**  LÍNEA DE
ATENCIÓN AL
CONSUMIDOR
ESPAÑA

**902
400
423**  SERVICIO
TÉCNICO
ESPAÑA

3-92500890